



GULLIVER

Design by Davy Grosemans





CREATING PARASOLS FOR PROFESSIONALS

GULLIVER

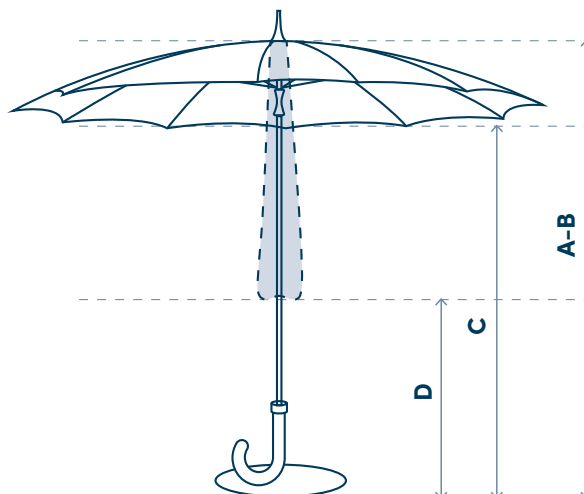
Technical details

Design by Davy Grosemans



PARASOL		Ø 295 cm
Shape		
Dimensions	A - Height closed	266 cm
	B - Height open	266 cm
	C - Free height open	210 cm
	D - Free height closed	100 cm
	Weight	8 kg
	Packaging size	276 x 30 x 28 cm
	Shade area (m ²)	± 7,07 m ²
Fabric	Top fabric	Airtex
	Top fabric colours	
	Ribbon colours	
Frame	Pole	Ø 35 mm
	Pole material	Anodised aluminium, powder coated
	Pole colours	
	Ribs	10 steel ribs - Paragon shape - Metallized and coated
	Ribs colours	
Protective cover		Polyester Ripstop® - grey



BASES

GULLIVER BASE 41 kg

Ø 74 cm - 10 mm - Steel QSTE 325 - Sandblasted, metallized and powder coated

Colours

white RAL 9010 - black RAL 9005

Wind resistance

5 Bft (38 km/h - 24 mph)



TUBE 6 kg

45 x 30 x 7 cm - Aluminium sandblasted and powder coated

Colours



POSSIBLE COLOUR COMBINATIONS

WHITE FRAME

Pole - ribs - base plate

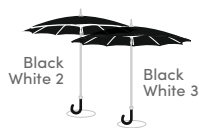

BLACK FRAME

Pole - ribs - base plate





Light Quaseo



Coupe + Bla Bla table
Black RAL 9005



Bla Bla table
white RAL 9010 – black RAL 9005



Protective Cover

www.symoparasols.com